

OPzV Tubular GEL Battery

OPzV2-800

CSPOWER OPzV series Tubular GEL battery is with 25 years floating design life, it is a Valve Regulated Tubular Gel battery that adopts immobilized GEL and Tubular Plate technology to offer high reliability and performance. The Battery is designed and manufactured according to DIN standards and with die-casting positive grid and patent formula of active material. OPzV series exceeds DIN standard values with more than 25 years floating design life at 25°C and is even more suitable for cyclic use under extreme operating conditions.

2V Voltage	800Ah Capacity	Tubular Technology	GEL Battery
----------------------	--------------------------	------------------------------	-----------------------



COMPLIED STANDARDS



GENERAL FEATURES

- It can discharge at -40°C~70°C, Charge at 0-50°C
- Long life expectancy of 20+ years in floating condition
- Adopts quality silicon nano gel electrolyte
- Excellent deep discharge recovery capability
- Deep cycle performance: up to 3300 cycles @50% DOD

APPLICATIONS

- Solar & Wind Power system
- Nuclear power station
- Telecom backup power supply
- energy saving requirements
- Emergency Power Systems

DIMENSIONS & WEIGHT

Length(mm/inch)	191/7.52
Width(mm/inch)	210/8.27
Height(mm/inch)	666/26.2
Total Height(mm/inch)	681/26.8
Weight(kg/lbs)(±3%)	65/143.3

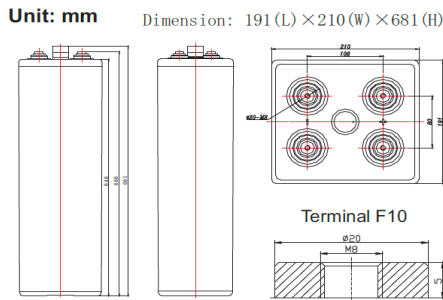

TECHNICAL SPECIFICATIONS

Nominal Voltage		2V(Single Cell)
Design Floating Life @25°C		25 Years
Nominal Capacity @25°C (10 hour rate@80.0A,1.8V)		800Ah
Capacity @25°C	20hour rate (42A,1.8V)	840Ah
	5 hour rate (136A,1.75V)	680Ah
	1 hour rate (505.6A,1.6V)	505.6Ah
Internal Resistance	Full Charged Battery@25°C	≤0.30mΩ
Ambient Temperature	Discharge	-40°C~70°C
	Charge	-0°C~50°C
	Storage	-20°C~60°C
Max.Discharge Current@25°C		3500A (5s)
Capacity affected by Temperature (10 hour)	40°C	105%
	25°C	100%
	0°C	89%
	-15°C	79%
Self-Discharge@25°C per Month		2%
Charge (Constant Voltage) @25°C	Standby Use	Initial Charging Current Less than 160.0A Voltage 2.25-2.3V
	Cycle Use	Initial Charging Current Less than 160.0A Voltage 2.37-2.4V

BATTERY DISCHARGE TABEL

Discharge Constant Current per Cell (Amperes at 25°C)

F.V/ Time	30min	1h	2h	3h	4h	5h	6h	8h	10h	20h
1.90	393.60	312.00	220.00	166.80	136.80	118.20	106.40	83.03	71.20	37.38
1.87	440.00	344.00	236.00	176.90	144.40	124.40	112.80	86.91	74.40	39.06
1.83	504.00	384.00	256.00	188.60	152.00	129.70	116.80	90.79	77.60	40.74
1.80	560.00	416.00	265.60	194.00	155.00	132.80	120.00	93.12	80.00	42.00
1.75	624.00	445.60	277.60	201.80	157.60	136.00	122.40	94.67	81.60	42.84
1.70	688.00	460.00	285.60	205.60	160.40	137.60	124.00	95.45	82.40	43.26
1.65	709.60	488.80	295.20	211.20	162.60	139.20	125.60	96.22	83.20	43.68
1.60	740.00	505.60	306.40	220.00	167.20	141.60	127.20	97.00	84.00	44.10

Discharge Constant Power per Cell (Watts at 25°C)

F.V/ Time	30min	1h	2h	3h	4h	5h	6h	8h	10h	20h
1.90	753.30	599.00	425.30	323.20	267.70	232.80	210.40	166.10	145.10	76.18
1.87	828.90	650.40	451.00	338.50	282.20	244.00	222.40	173.00	151.30	79.44
1.83	928.60	709.10	480.00	356.20	295.90	253.60	229.60	179.30	156.80	82.29
1.80	1015.00	756.60	496.10	364.20	301.50	259.20	235.20	183.10	160.60	84.33
1.75	1101.00	790.30	512.10	375.50	305.50	265.60	239.20	185.50	163.00	85.55
1.70	1180.00	798.40	525.00	381.90	310.30	268.00	241.60	187.00	164.50	86.37
1.65	1200.00	833.70	539.50	389.90	314.40	270.40	244.00	188.60	165.30	86.78
1.60	1215.00	859.50	552.30	402.80	322.40	272.80	245.60	189.30	166.10	87.18

OPzV Tubular GEL Battery

OPzV2-800

PERFORMANCE CHARACTERISTICS

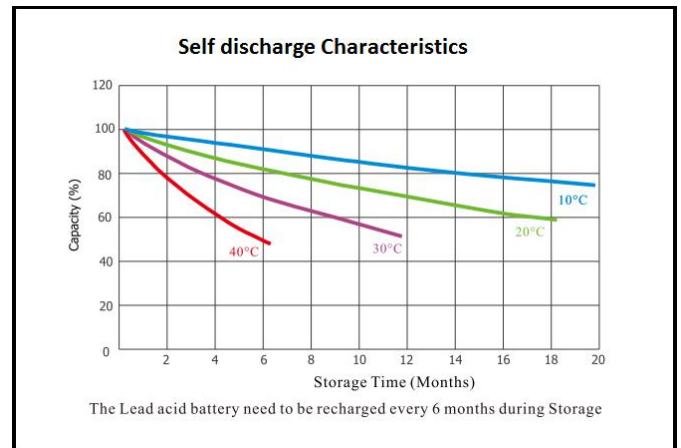
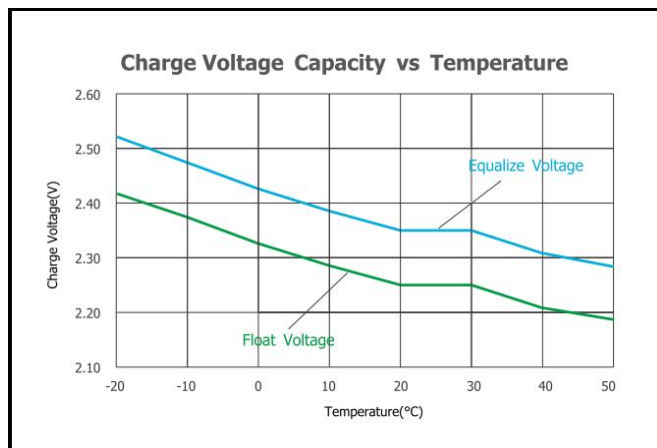
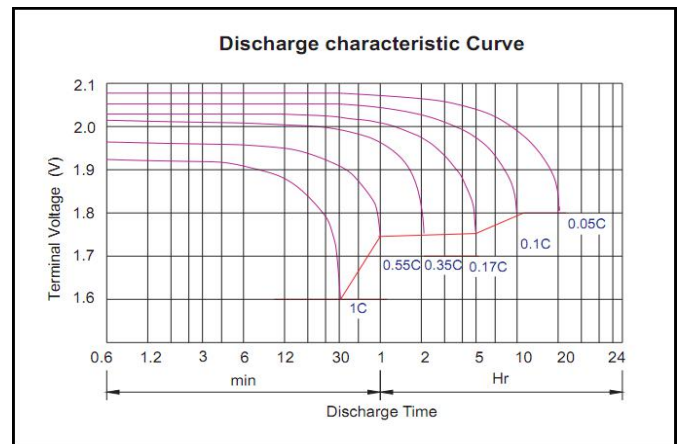
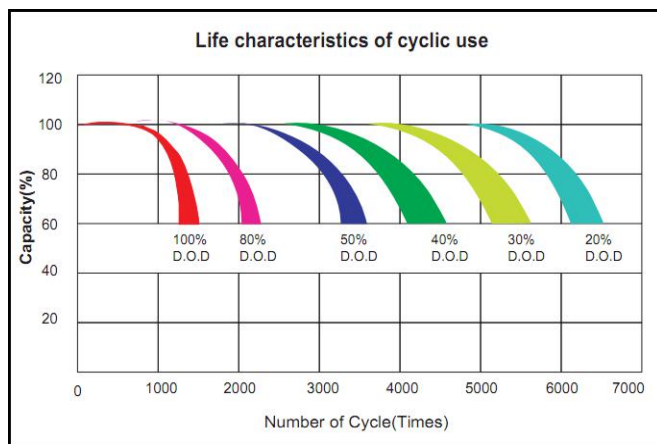
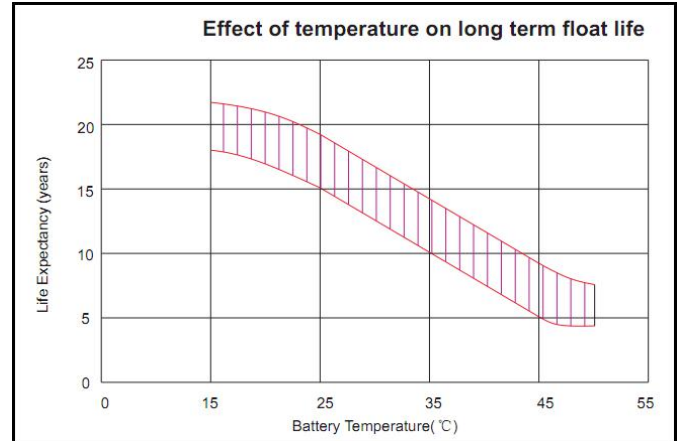
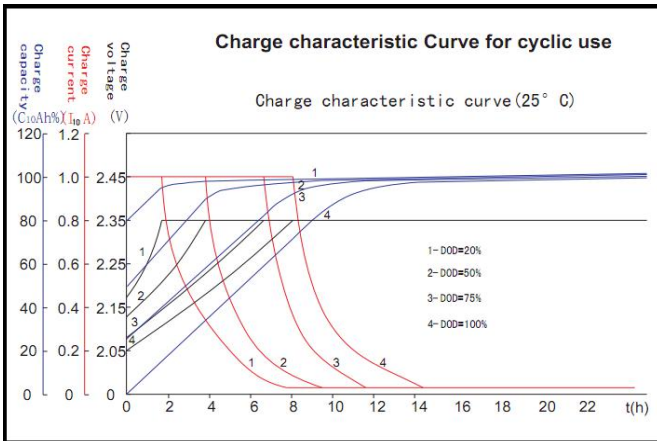

Battery Discharge Capacity

Long time discharge capacity for solar/wind application						
Capacity Model	C24 (Ah)	C48 (Ah)	C72 (Ah)	C100 (Ah)	C120 (Ah)	C240 (Ah)
	OPzV2-800	890	1000	1006	1020	1037

F.V=1.85VPC

Note: The above data are average values, and can be obtained within 3 charge/discharge cycles. These are not minimum values. Cell and battery designs/specifications are subject to modification without notice. Contact CSPOWER for the latest information.

Shenzhen CSPOWER Battery Technology Co.,Ltd.

Add: Building B, Huafeng Technology Park, Baoan, Shenzhen, China.
Tel: +86-755-29123661 Email: sales@csagmbattery.com

[HTTP://WWW.CSAGMBATTERY.COM](http://www.csagmbattery.com)