



乐清市裕林电子有限公司

Yueqing Yulin Electronic Co., Ltd

ADD:No.721 Huancheng East Road ,Tantou Village ,Liushi,YueQing,Zhejiang China 325604

TEL.: 0577-27878383

Website: www.pilotlamp.cn

FAX: 0577-27878383

SPECIFICATION FOR APPROVAL

承 认 书

CUSTOMER'S CODE

客户代码: _____

DESCRIPTION

品 名: _____ 信号灯

SPECIFICATION

规 格: _____ FL1P-10JN-2

DATE

送样日期: _____

PART NO.

本厂型号: _____ FL1P-10JN-2

REFERENCE No.

档案号: _____ WYY1

NUMBER OF SAMPLE

送样数量 _____

COPY OF ACKNOWLEDGEMENT

承认书份数 _____

Approved By Customer 客户承认	Qualified By 核 准	Form Designer 制 作
------------------------------	---------------------	----------------------

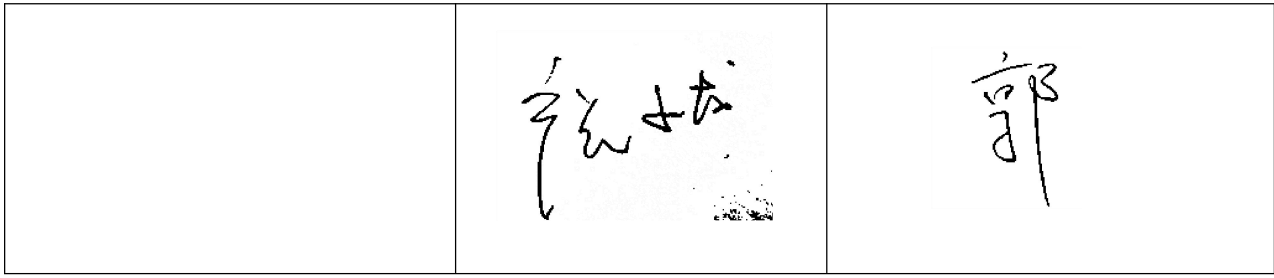

乐清市裕林电子有限公司

Yueqing Yulin Electronic Co., Ltd

ADD:No.721 Huancheng East Road ,Tantou Village ,Liushi,YueQing,Zhejiang China 325604

TEL.: 0577-27878383

Website: www.pilotlamp.cn

FAX: 0577-27878383

1. Description :

-LED (A class quality)

-200k 1/2w resistor

2. Picture:





乐清市裕林电子有限公司
Yueqing Yulin Electronic Co., Ltd

ADD:No.721 Huancheng East Road ,Tantou Village ,Liushi,YueQing,Zhejiang China 325604

TEL.: 0577-27878383

Website: www.pilotlamp.cn

FAX: 0577-27878383

3.Drawing:

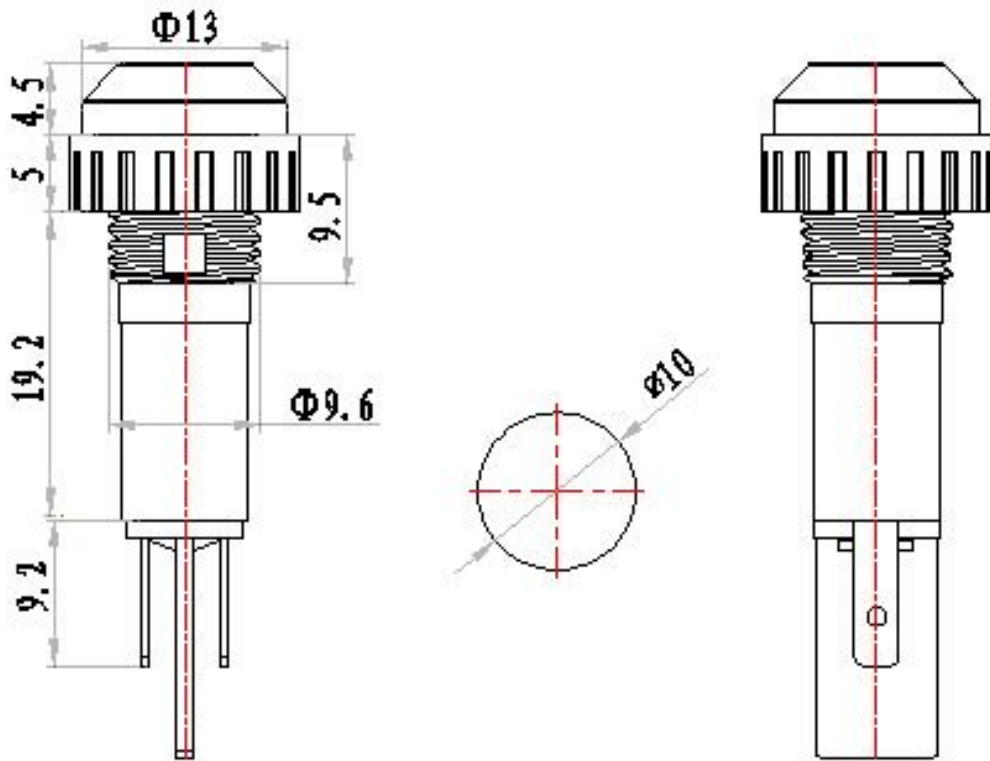



乐清市裕林电子有限公司

Yueqing Yulin Electronic Co., Ltd

ADD: No.721 Huancheng East Road, Tantou Village, Liushi, YueQing, Zhejiang China 325604

TEL.: 0577-27878383

Website: www.pilotlamp.cn

FAX: 0577-27878383

4. Detailed Picture :

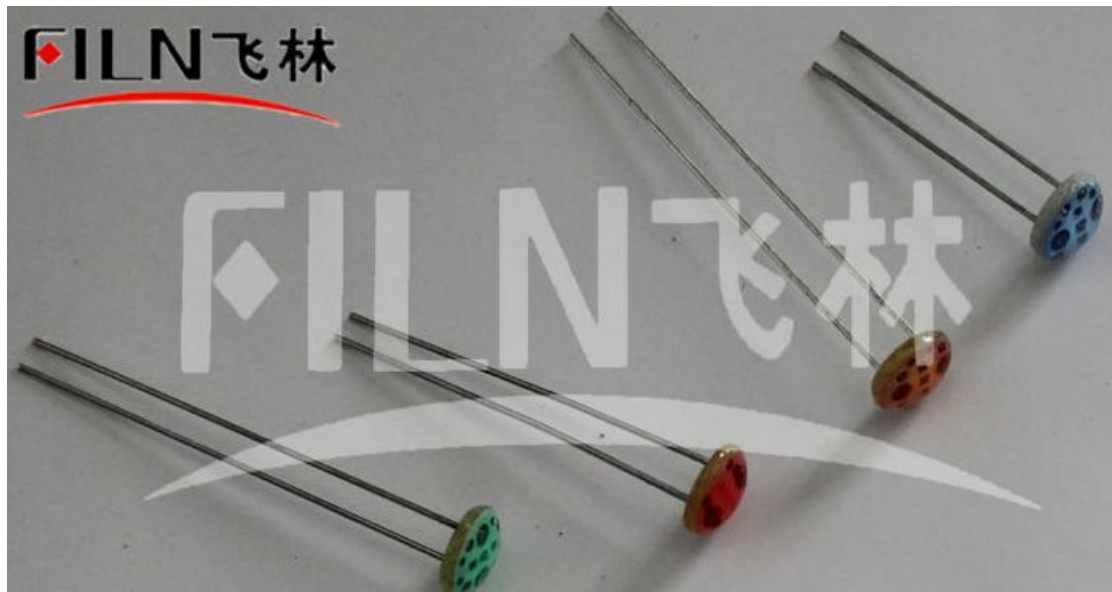

5. LED Specification:

■ Emitter 外型图

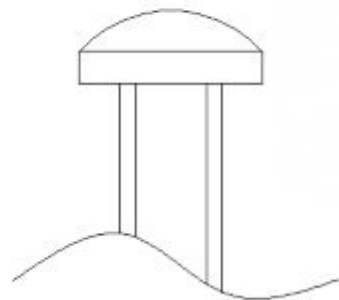
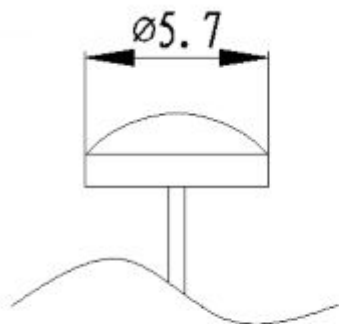

Spatial Distribution

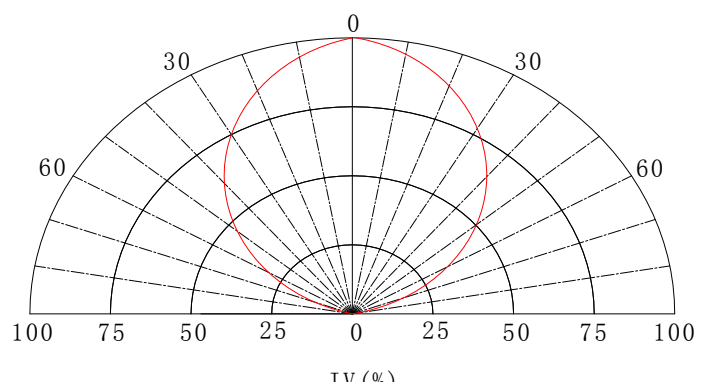

FILN 飞林



乐清市裕林电子有限公司

Yueqing Yulin Electronic Co., Ltd

ADD: No. 721 Huancheng East Road, Tantou Village, Liushi, Yueqing, Zhejiang China 325604

TEL.: 0577-27878383

Website: www.pilotlamp.cn

FAX: 0577-27878383

■ Absolute Maximum Rating 极限工作参数

参数 Parameter	符号 Symbol	单位 Unit	极限参数 Maximum Rating
耗散功率 Power Dissipation	P	MW	60
连续正向电流 Continuous Forward Current	I _F	MA	25
反向电压 Reverse Voltage	V _R	V	5
工作温度范围 Operating Temperature Range	Top	°C	-25 to +80
存放温度范围 Storage Temperature Range	Tst	°C	-25 to +90
最高焊接温度 Soldering Temperature	Tso	°C	260 (for 5 second)

*Ifp Conditions: Pulse Wide ≤ 10msec ≤ 1/10
base of epoxy bulb 最高焊接温度 距胶体 3mm

瞬间脉冲电流 *Tsol Conditions: 3mm from the



乐清市裕林电子有限公司

Yueqing Yulin Electronic Co., Ltd

ADD:No.721 Huancheng East Road ,Tantou Village ,Liushi,YueQing,Zhejiang China 325604

TEL.: 0577-27878383-8016

Website: www.pilot.cn

FAX: 0577-27878383-8008

Typical Optical/Electrical Characteristics 光电特性参数

Color parameters 色参数		Optical Brightness 光亮度	0.00 cd/m ²
Main Wavelength 主波长	520.7.0 nm	light intensity 光强度	1000 mcd
Peak Wavelength 峰值波长	632.2 nm	luminous flux 光通量	4.8 lm
Peak width 峰值带宽	21.3 nm	luminous power 光功率	0.32 mW
colour coordinates xy 色坐标 xy	(.1404.7126)	luminous efficacy 发光效率	56.81 lm/W
colour coordinates u'v' 色坐标 u'v'	(.0498.5690)	forward current 正向电流	20.00 mA
colour purity 色纯度	0.758	alternating voltage 交流电压	4.22 V
Color temperature 色温	8400k	AC power 交流电功率	0.084 W

Notes:

1. Work absolute ratings Ta=25°C humidity=60% 工作常规值 温度=25°C 湿度=60%
2. Tolerance of measurement of forward voltage±0.1V 正向电压误差范围±0.1V
3. Test Machine: SSP6612 series LED test system



乐清市裕林电子有限公司
Yueqing Yulin Electronic Co., Ltd

ADD: No.721 Huancheng East Road, Tantou Village, Liushi, Yueqing, Zhejiang China 325604

TEL.: 0577-27878383-8016

Website: www.pilot.cn

FAX: 0577-27878383-8008

Typical electrical-optical Characteristics curves

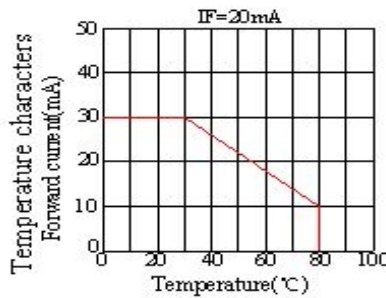
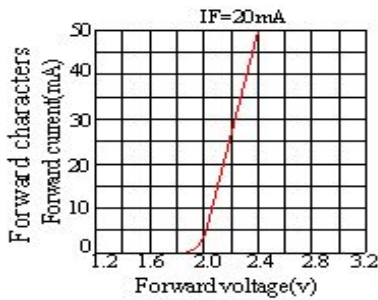

Notes:

The data are an typical presentation of the product, Contact customer service for details of technical information and warranty. The product is sensitive to static antistatic operation environment is recommended. Products are shipped in either bulk bag package or taping.

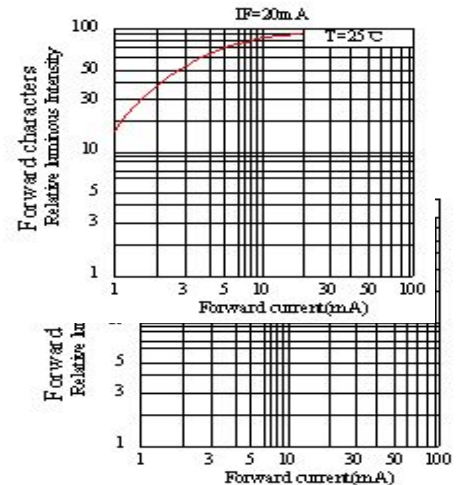
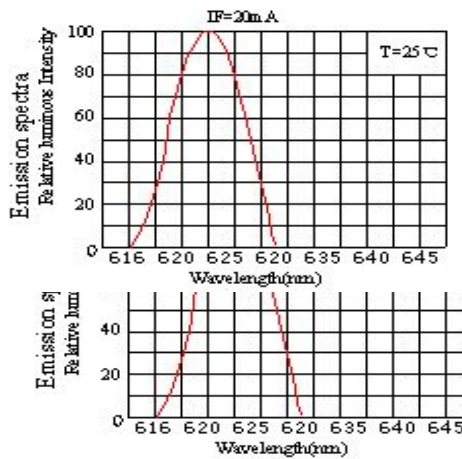
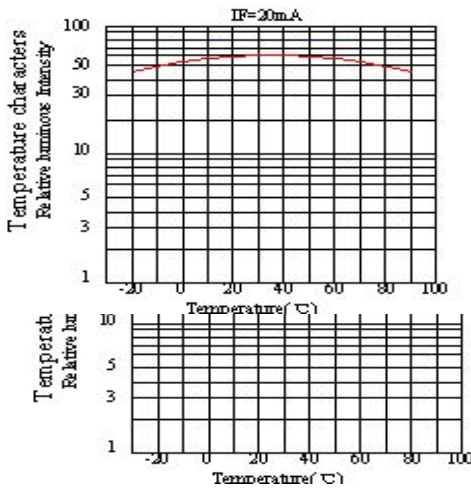

LED LAMP RELIABILITY

● **Test Items And Results**

* Refer to reliability test standard specification for in this line.

● **Criteria for Judging The Damage**



乐清市裕林电子有限公司

Yueqing Yulin Electronic Co., Ltd

Type	Test Item	REF. Standard	Test Condition	Note	Number of Damaged
Environmental Sequence	Temperature Cycle	JIS C 7021 (1997) A-4	-20℃→25℃→80℃→25℃ 30mins,5mins,30mins,5mins	100 cycles	0/100
	High Humidity Heat Cycle	JIS C 7021 (1997) A-5	30℃→65℃ 90%RH 24hrs/1cycle	10 cycles	0/100
	High Temperature Storage	JIS C 7021 (1997) B-10	Ta=80℃	1000hrs	0/100
	Humidity Heat Storage	JIS C 7021 (1997) B-11	Ta=60℃ RH=90%	1000hrs	0/100
	Low Temperature Storage	JIS C 7021 (1997) B-12	Ta= -30℃	1000hrs	0/100
Operation Sequence	Life Test	JIS C 7035 (1985)	Ta=25℃ If=20mA	1000hrs	0/100
	High Humidity Heat Life Test	*	60℃ RH=90% If=20mA	500hrs	0/100
	Low Temperature Life test	*	Ta= -20℃ If=20mA	1000hrs	0/100
Destructive Sequence	Resistance to Soldering Heat	JIS C 7021 (1997) A-11	Tsol=260 ± 5℃,10sec (3mm from the base of the epoxy bulb)	1 time	0/20
	Solder ability	JIS C 7021 (1997) A-2	Tsol=235 ± 5℃,5sec (Using flux)	1 time (over 95%)	0/20
	Lead Pull/Bend Test	JIS C 7021 (1997)A-11	Load 2.5N (0.25kgf) 0°→90°→0° Bending 3 times	No noticeable damage	0/20

ADD:No.721 Huancheng East Road ,Tantou Village ,Liushi,YueQing,Zhejiang China 325604

TEL.: 0577-27878383

Website: www.pilotlamp.cn

FAX: 0577-27878383

6. Resistor Specification (RMS 1/4W 200kΩ):

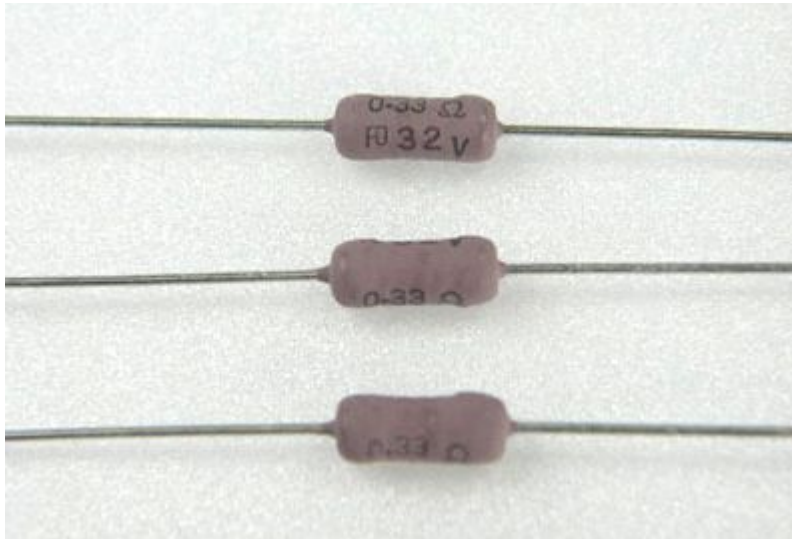

■ CHARACTERISTICS 性能

	Symbol	Test Condition	Criteria for Judgment	
			Min.	Max.
Forward Voltage	V_F	$I_F = 20\text{mA}$	---	Initial data x 1.1
Reverse Current	I_R	$V_R = 5\text{V}$	---	Initial data x 2.0
Luminous Intensity	I_v	$I_F = 20\text{mA}$	Initial data x 0.7	---

ITEM 项目	SPEC 规格	REMARKS 备注
Load life under high temperature 高温负荷寿命	±1.5%	JIS C 5201-1 (4.25.1) Rated voltage at 70°C for 1,000 hours 额定电压70°C 1,000小时
Load life under high humidity 耐湿负荷寿命	±5%	JIS C 5201-1 (4.24) Rated voltage at 40°C,95% RH for 1,000 hours 额定电压40°C,95% RH 1,000小时
Temp. coeff of resistance 温度系数	< 1K= ±500 PPM/°C ≤ 100KΩ=±300 ppm/°C >100KΩ=±200 ppm/°C	JIS C 5201-1 Room temp. + 100°C, 30min 室温 + 100°C, 30分钟
Short time overload 短时间过负荷	±1%	JIS C 5201-1 (4.13) 6.25 times the rated power for 5 seconds 6.25倍额定功率 5秒
Temperature cycling 温度循环	±1%	JIS C 5201-1 (4.19) 5 cycles for -25°C±3°C(30min); room temp.(30min) ~ +85°C±3°C(30min) room temp. (30min)
Resistance to soldering heat 焊锡耐热	±1%	JIS C 5201-1 (4.18) 260°C±5°C for 10 seconds(焊锡槽) 350°C±10°C for 3.5 seconds(手焊锡)
Insulation resistance 绝缘电阻	>1,000MΩ	JIS C 5201-1 (4.6.1.1) 500 volt Insulation test 1min 500 V绝缘测试电压1分钟



乐清市裕林电子有限公司

Yueqing Yulin Electronic Co., Ltd

ADD: No.721 Huancheng East Road, Tantou Village, Liushi, Yueqing, Zhejiang China 325604

TEL.: 0577-27878383

Website: www.pilotlamp.cn

FAX: 0577-27878383

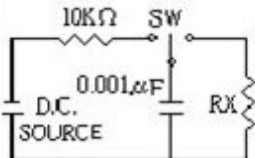
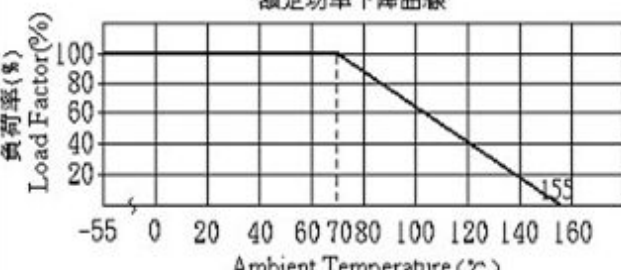
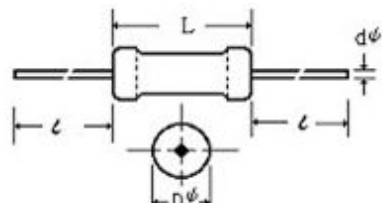
<p>Pulse withstanding voltage 脉冲</p>	<p>±20%</p>	<p>■The following discharge cycle is repeated in the circuit of the left fig. 2.5 sec. ON 2.5 sec. OFF 50 cycles. With following DC pulse test voltage ■ Pulse voltage: 1/6W, S1/4W: 3KV. ≥1/4W: 100KΩ: (3KV); 100KΩ-620KΩ: (5KV); > 620KΩ: (10KV)</p> 
<p>DERATING CURVE 额定功率下降曲线</p> 		
<p>Various type of forming & taping are available</p>		<p>提供插装的造型与带装</p>
<p>Coating color: RMU1/4W, RMU1/6W, dark blue, other, pink.</p>		<p>涂装颜色: RMU1/4W, RMU1/6W 蓝色, 其他粉红色。</p>

■ CHARACTERISTICS 性能

Model 型名	Power Rating 额定功率 (W)	Resistance Range E-24 阻值范围 Ω	Maximum Working Voltage 最高使用 电压	Dielectric Withstandi ng Voltage 耐电压	Dimension 尺寸 (mm)			
					L	D φ	t	d φ
RMU1/4W 、 RMS1/2W	1/4, 1/2	10Ω ~ <100M	1600V	700V	6±0.3	2.4±0.1	28±2	0.6±0.05